

max TX™ SERIES
Model TX-A2
Audio Converter – Balanced to Unbalanced

- Unbalanced Audio Outputs from a Balanced Line
- Balanced to Unbalanced Conversion
- Mono Input to Stereo Output
- +4 dBu Input Level to -10 dBV Output Level
- Studio-Quality Transformer Isolation
- Passive Converter with Output Jacks



Model TX-A2D
Dual Audio Converter – Balanced to Unbalanced

- Unbalanced Audio Outputs from a Stereo Balanced Line
- Balanced to Unbalanced Conversion
- Stereo Input to Stereo Output
- +4 dBu Input Level to -10 dBV Output Level
- Studio-Quality Transformer Isolation
- Passive Converter with Output Jacks



The TX-A2 and TX-A2D are audio output transformer modules in the convenient line of Max-TX products. Max-TX modules are the large format members of the RDL TX family, featuring the superior engineering and components common to RDL products. The durable adhesives provided with these modules permit permanent or removable mounting. They may be rack or surface mounted with optional TX series accessories.

TX-A2 APPLICATION: The TX-A2 is the ideal choice in installations requiring passive isolation and level attenuation between a professional balanced line-level mono source and consumer equipment unbalanced inputs.

The TX-A2 is a complete unbalanced line-level audio output module. The front panel provides a detachable terminal block for connection of a balanced +4 dBu audio source. The input signal is coupled to two front-panel gold plated RCA jacks through a studio-quality isolation transformer. Each output is coupled through an attenuation network that produces a nominal -10 dBV level. Both output jacks may be used to feed two mono equipment inputs or one stereo input. A single output jack may be used for mono. Shielding is provided by the TX-A2's heavy duty aluminum enclosure.

TX-A2D APPLICATION: The TX-A2D is the ideal choice in installations requiring passive isolation and level attenuation between a professional balanced line-level stereo source and consumer equipment unbalanced inputs.

The TX-A2D is a complete unbalanced stereo line-level audio output module. The front panel provides a detachable terminal block for connecting each channel of a balanced +4 dBu audio source. The input signals are coupled to two front-panel gold plated phono jacks through studio-quality isolation transformers. Each output is coupled through an attenuation network that produces a nominal -10 dBV level. Shielding is provided by the TX-A2D's heavy duty aluminum enclosure.

Wherever professional format audio signals need to be converted to an unbalanced line level, the TX-A2 and TX-A2D are an ideal choice. Use them individually or in conjunction with other RDL products as part of a complete audio/video system.

max TX™ SERIES
Models TX-A2 and TX-A2D
Audio Converters

Installation/Operation

CE EN55103-1 E1-E5; EN55103-2 E1-E4
Typical Performance reflects product at publication time exclusive of EMC data, if any, supplied with product. Specifications are subject to change without notice.

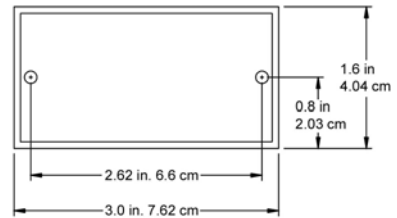
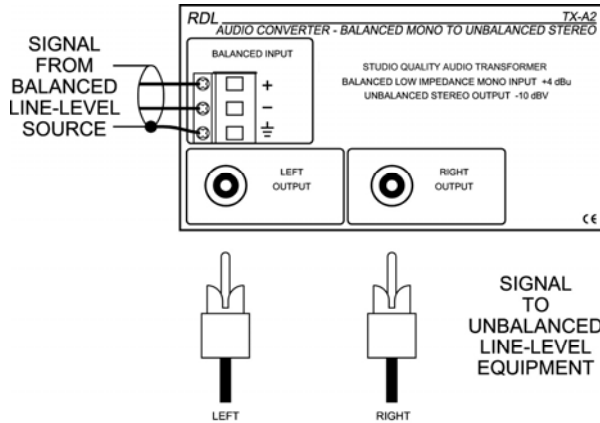

Mounting Dimensions

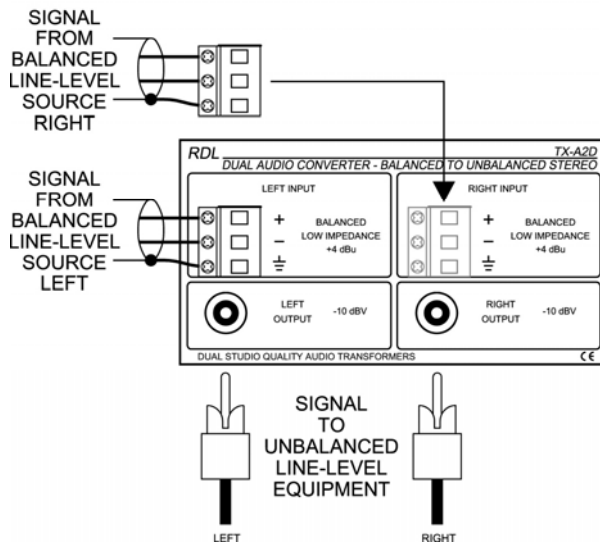

TYPICAL PERFORMANCE

Input connector (TX-A2: 1; TX-A2D: 2):	Detachable terminal block
Input level:	+4 dBu nominal; +22 dBu max
Output connectors (2):	Gold plated phono jacks
Output level:	-10 dBV nominal
Frequency response (line level):	20 Hz to 20 kHz (± 0.5 dB)
Crosstalk (TX-A2D):	<-80 dB (20 to 20 kHz, ref. -10 dBV); <-90 dB (1 kHz)
Total Harmonic Distortion:	<0.05% (20 Hz to 20 kHz, +4 dBu input); <0.01% (1 kHz)
Dimensions:	
	Height: 2.4 in. 6.1 cm
	Length: 3.0 in. 7.6 cm
	Width: 1.6 in. 4.0 cm